

# TKR5448

## COMPLETE REAR DIFFERENTIAL

### (OVERVIEW)

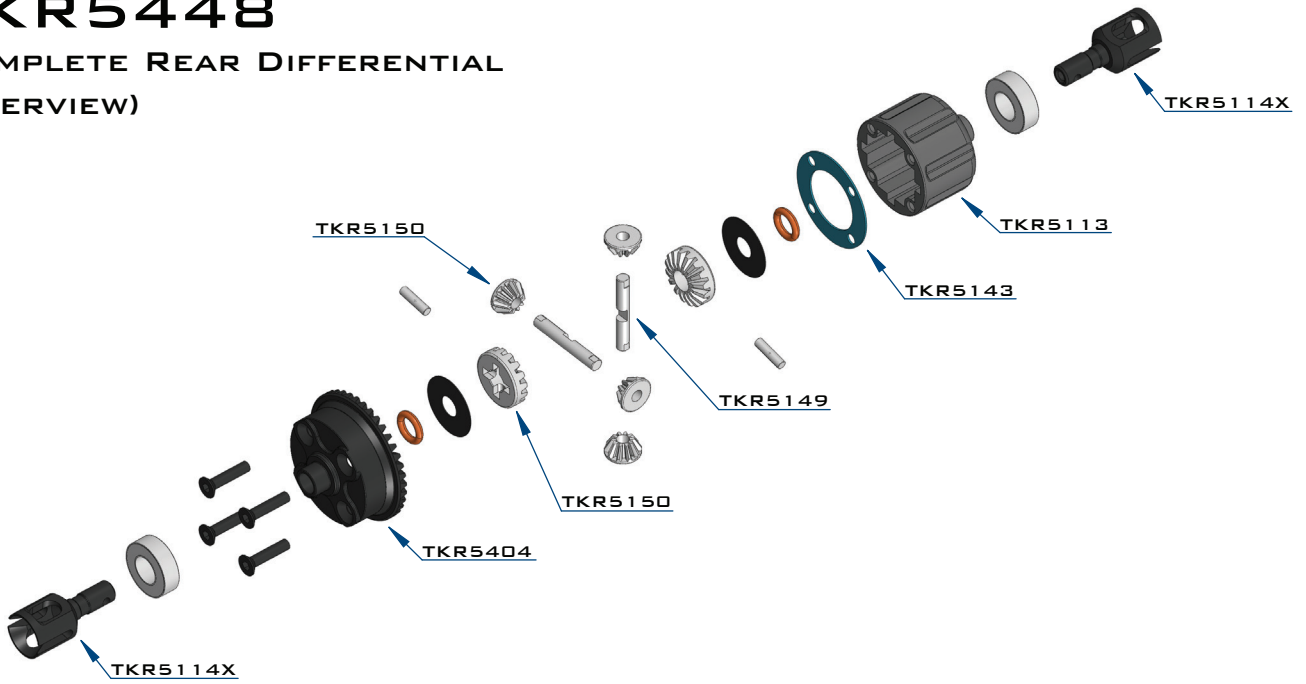

#### STEP 1

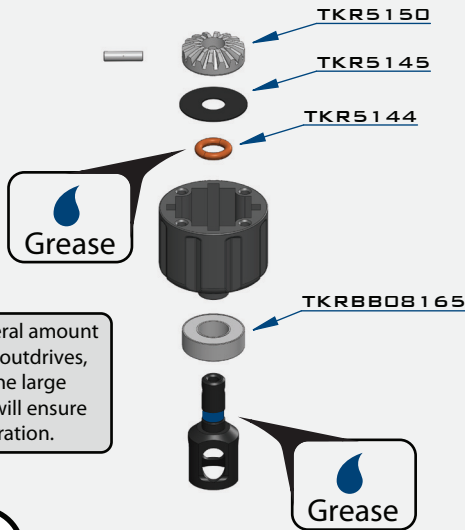

#### STEP 2

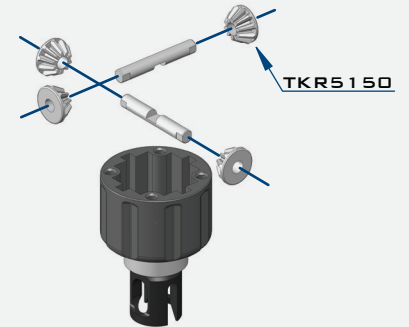

#### STEP 4

**Note:** Apply a liberal amount of grease in the areas between the shims and o-rings, as well as around the outdrive and both sides of the seal

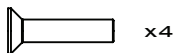
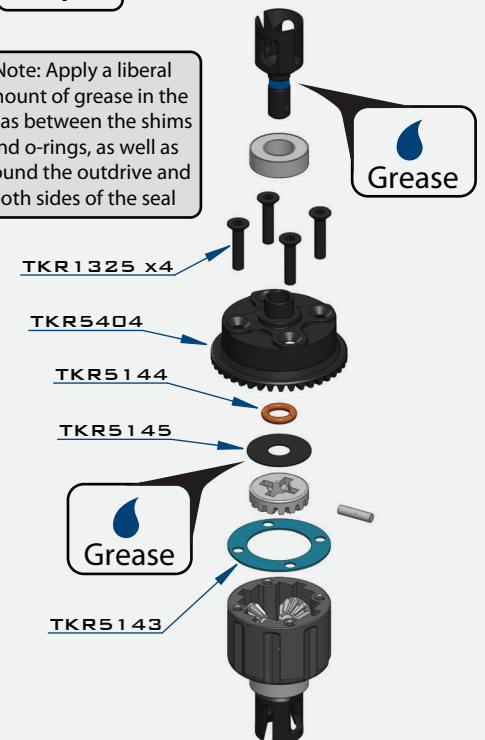

TKR1325  
M3X14MM FLAT HEAD SCREW



TKR5144  
DIFFERENTIAL O-RINGS

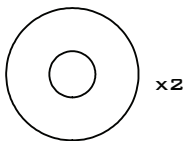

TKR5145  
DIFFERENTIAL SHIMS (6X17MM)

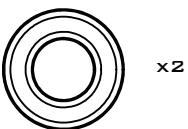

TKRBB08165  
BALL BEARING(8X16X5MM)

#### STEP 3



Fill oil to  
1mm below full